

Aydınlatma Konsolları /Lighting Brackets

Konsollar; direklere üstten monte edilecek şekilde tek konsollu, iki konsollu, üç konsollu ve dört konsollu olarak üretilir. Boyları 0.20 metreden 3 metreye kadar olabilir. Sıcak daldırma galvaniz ya da elektro galvaniz kaplama yapılır. Müşteri talebine göre sıcak daldırma kaplama üzeri elektrostatik fırın boya işlemi de yapılabilmektedir. Renk seçeneği mevcuttur.

The brackets are produced as single bracket, two bracket, three brackets and four bracket mounted on the poles from the top. Brackets can be produced 0.20 meters to 3 meters in length. Brackets are coated hot dipped galvanizing or electro galvanizing. According to the customer's request, the brackets can be painted electrostatic powder paint over the hot dip galvanizing. Colour option is available.



Projektör Bağlantı Konsolları /Projector Mounting Brackets

Projektör bağlantı konsolları direklere üstten monte edilecek şekilde üçgen , kare , çok kenarlı ve dairesel olarak üretilir. Boyları ve çapları müşteri talebine göre projelendirilip üretilmektedir. Sıcak daldırma galvaniz ya da elektro galvaniz kaplama yapılır. Müşteri talebine göre sıcak daldırma kaplama üzeri elektrostatik fırın boya işlemi de yapılabilmektedir. Renk seçeneği mevcuttur.

The projector brackets are produced as triangle bracket, square bracket, circular brackets and hexagonal bracket mounted on the poles from the top. Brackets heights and dimensions can be produced according to customers' requests.. Brackets are coated hot dipped galvanizing or electro galvanizing . According to the customer's request, the brackets can be painted electrostatic powder paint over the hot dip galvanizing . Colour option is available.

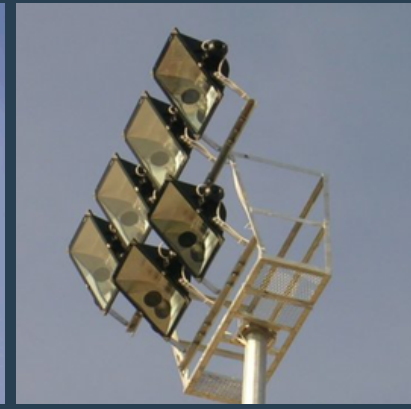
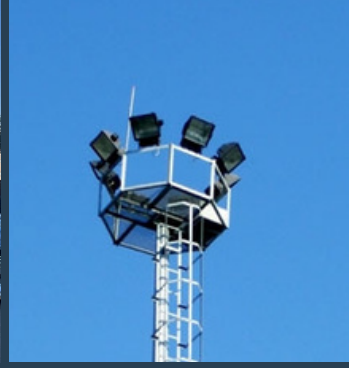

Kamera Konsolları /Cctv Brackets

Kamera konsolu görüntü alınmak istenen alanın yakınında bulunan duvar elemanlarına ve direklere , üstten yada gövdeye monte edilerek istenen görüş alanını görmeyi ve güvenliği sağlar. Boyları ,çapları, montaj şekli ve açısı müşteri talebine göre projelendirilip üretilmektedir. Sıcak daldırma galvaniz ya da elektro galvaniz kaplama yapılır. Müşteri talebine göre sıcak daldırma kaplama üzeri elektrostatik fırın boya işlemleri de yapılabilmektedir. Renk seçeneği mevcuttur.

The camera brackets are mounted top on the pole, pole body or on the wall which are provided to bring out security view of fields. Brackets heights , dimensions, mounting type and angles are engineered according to customers' requests. Brackets are coated hot dip galvanized and optionally electrostatic powder paint.

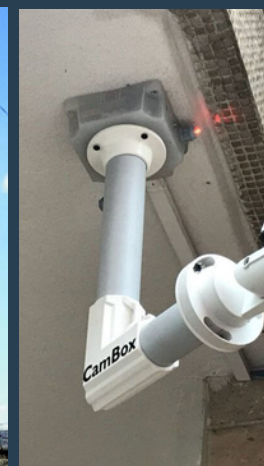
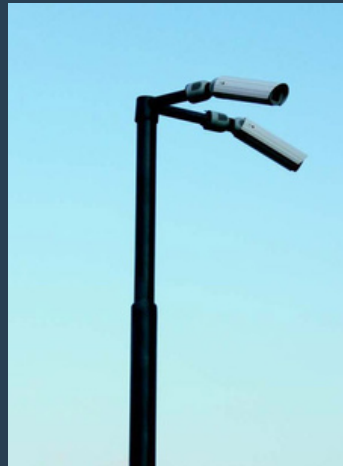
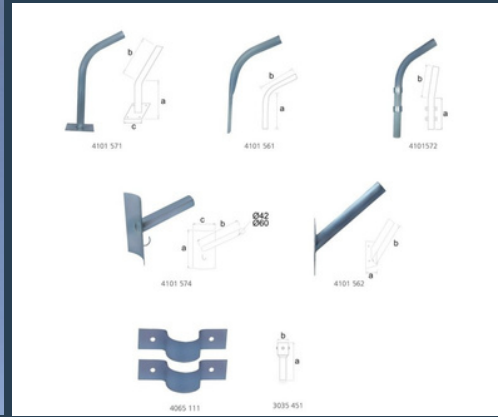
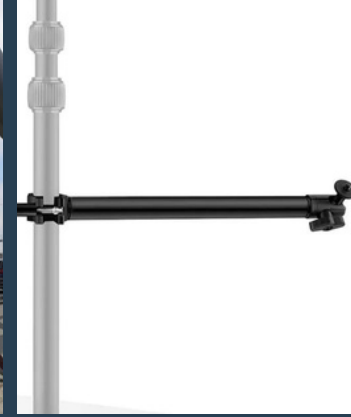

Bayrak Direği Aksesuarları/Flag Poles Accessories

Bayrak direği aksesuarları ; ip , çelik halat , sonsuz döner sistemi , ağırlıklar , küre , ay yıldız , redüktör , motor rulman sisteminden oluşmaktadır. Zamanla ve çevresel unsurların da etkisiyle aksesuarlarda deformasyonlar meydana gelmektedir. Bütün aksesuarlar direğin yapısına ve boyutuna uygun olacak şekilde tedarik edilerek değişimi yapılır.

Flag Poles Accessories is consists of rope, steel rope, endless rotary systm, weight balls, reductor, motor and bearing . The corrosions are occured on the accessories due to time effect and enviromentals considerations are occured the damages . All accessories are supplied and renew according to structure and size of the pole.

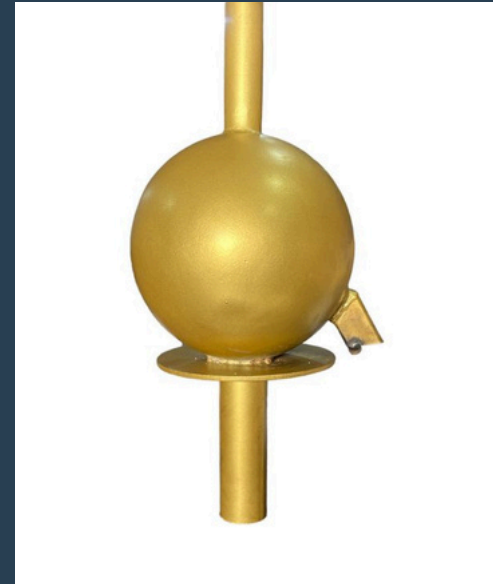
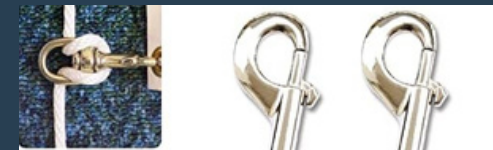
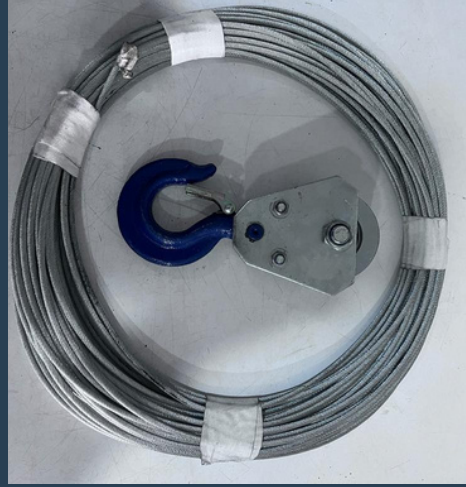

Dekoratif Aksesuarlar/Decorative Accessories

Direk Dibi Alt Kaideler /Decorative Base Cover

Direklerin şık ve estetik görünmesini sağlayan parçalardır. Müşteri talebine göre projelendirip üretilir. Renk seçeneği mevcuttur.

Decorative accessories and decorative base covers are provided to seem more stylish and aesthetic. Colour option is available.



Sigorta Kapaklar /Fuse Covers

Aydınlatma direği kapaklarımız 1,5 mm siyah dkp saçtan ya da kompozit malzemeden üretilmektedir. Kapaklar menteşe sistem ya da vida ile direklere monte edilmektedir. Sıcak daldırma galvaniz kaplama ile kaplanan ürünler müşteri talebine göre boyanabilir.

The covers are made of 1.5mm black dkp steel sheet or CTP composite which are mounted hinged system or self tapping screws on the poles. The covers are coated hot dip galvanized and optionally electrostatic powder paint.

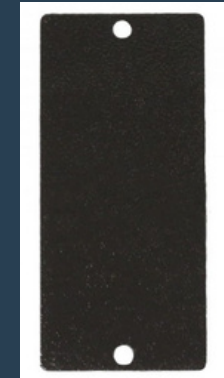
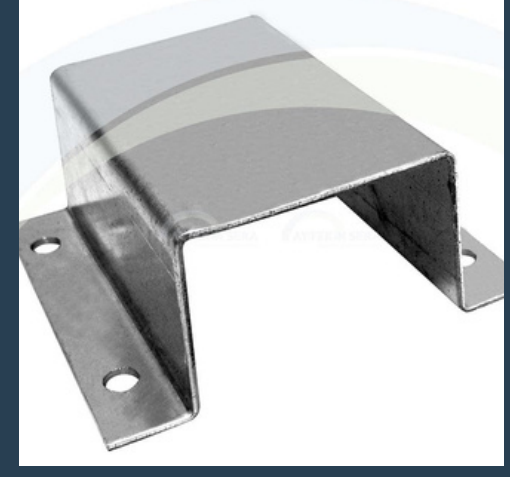

Ankraj Setleri ve Taban Adaptörleri /Anchor Bolts and Base Adapters

Bir çelik donatının ya da yapı elemanının başka ortam, başka eleman veya başka malzeme arasına sokularak sabitlenmesi işlemidir. Yani ankraj işleminde amaç demir ya da çelik malzemesini duvar veya kolon yüzeyine yani beton içerisine yerleştirmektir. Ankraj cıvataları genellikle özel çekiçler kullanılarak deliklere sokulur ve sürtünme genişmesi ile taban malzemesine sabitlenir. Taban Adaptörleri ise ; ankraj ile direk tabanı arasındaki uyumsuzluklarını gidermek için sunulan çözümdür.

Anchor bolts are structural and non-structural elements that fasten a light pole to a poured concrete foundation. Anchor bolts are made of steel specifically designed to serve as a light pole anchor, keeping the pole in place. Each anchor bolt consists of a hooked threaded rod, a hex nut, and a washer. Anchor bolts are usually inserted into the holes using special hammers and fixed to the base material by friction expansion.

Base adapter is the best solution when your light pole's base plate doesn't line up with your existing anchor bolt foundation which is provided solution.

